



Société Nationale de
Certification et d'Homologation
Société à responsabilité limitée











October 14th, 2010

STATEMENT

We confirm, that the following replacement silencer type 4588, produced by SITO Gruppo Industriale S.p.A. (S.G.I.), is complying with

- the EC-Directive 97/24/EC Chapter 9 regarding permissible sound level and exhaust system

An EC type approval number has been granted by the luxembourgian Ministry for Sustainable Development and Infrastructure, department of Transport, for the following version of the above mentioned replacement silencer type:

Silencer Version	Drawing No.	Type approval number	Vehicle type	Vehicle Model
5508	4566	SGI  0459 	MZF1- ZD4MZC	APRILIA SR 50 Stealth
5508	4566	SGI  0459 	MZF1 – ZD4MZC	APRILIA SR 50 Racing
5508	4566	SGI  0459 	44 ver.B2 var.K1	MALAGUTI F15 Firefox (Liquid cooled)
5508	4566	SGI  0459 	SA14 – 5SB	MBK Nitro 50 kat
5508	4566	SGI  0459 	SA14 – SA141 – 5BR – 5SB	YAMAHA Aerox 50 kat



Gilles AST
Expert Technique

Adresse:
BP 23
L-5201 Sandweiler

Siège social:
11, route de Luxembourg
L-5230 Sandweiler

Capital social: 3.500.000 €
R.C. B 27180
N° TVA: LU 13770825

Tél.: (+352) 35 72 14 - 250
Fax: (+352) 35 72 14 - 244
E-mail: info@snch.lu
Home page: www.snch.lu



9933380

Solo per - only for - Seulement pour
- Nur für - Sólo para:
Malaguti F15 Firefox L/C

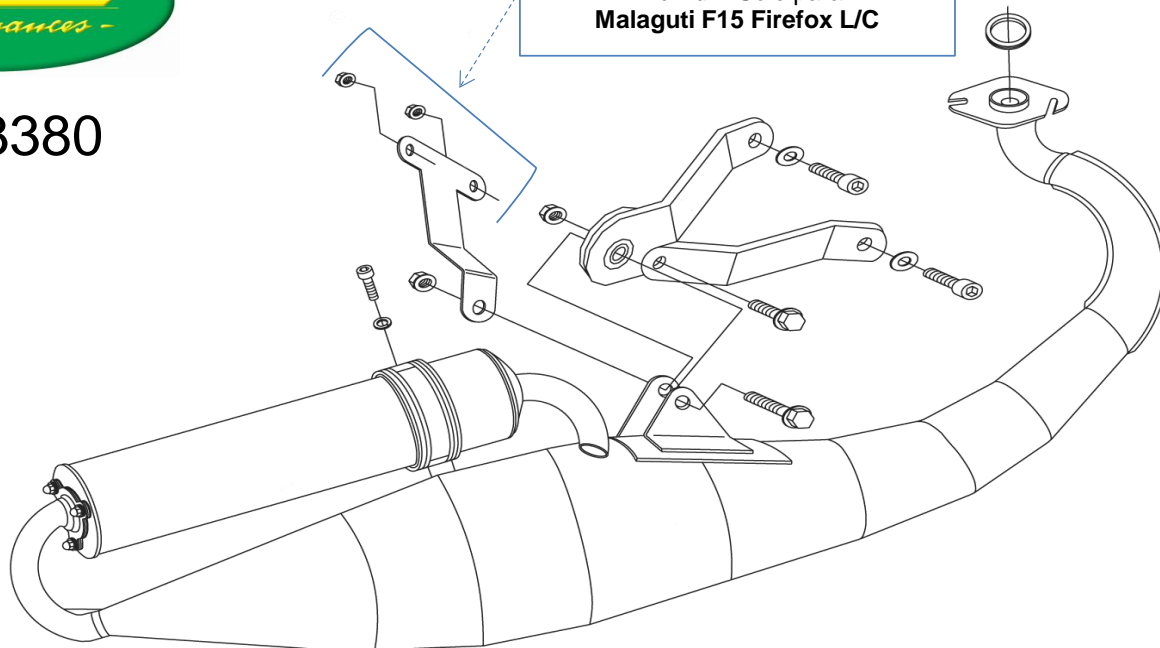

RULLI E MOLLE-ROLLERS AND SPRINGS-MASSELOTTES ET RESSORTS-ROLLEN UND FEDERN-RODILLOS Y MUELLES

Rulli: (art. 4645 – gr. 4,3 per APRILIA SR STEALTH - APRILIA SR RACING - MBK NITRO 50 - YAMAHA AEROX 50 e gr. 3,5 per MALAGUTI F15 FIREFOX). **Molle:** (MINARELLI HARD GIALLE).

Rollers: (art 4645 – 4,3 g. for APRILIA SR STEALTH - APRILIA SR RACING- MBK NITRO 50 - YAMAHA AEROX 50 and gr. 3,5 for MALAGUTI F15 FIREFOX). **Springs:** (MINARELLI HARD GIALLE).

Masselottes: (ref. 4645 - 4,3 grammes pour APRILIA SR STEALTH - APRILIA SR RACING - MBK NITRO 50 - YAMAHA AEROX 50 et gr. 3,5 pour MALAGUTI F15 FIREFOX). **Ressort:** (MINARELLI HARD JAUNES).

Rodillos: (art. 4645 – gr. 4,3 por APRILIA SR STEALTH - APRILIA SR RACING - MBK NITRO 50 - YAMAHA AEROX 50 y gr. 3,5 por MALAGUTI F15 FIREFOX). **Muelles:** (MINARELLI HARD GIALLE).

Rollen: (Art. 4645 - gr. 4,3 für APRILIA SR STEALTH - APRILIA SR RACING - MBK NITRO 50 - YAMAHA AEROX 50 und gr. 3,5 für MALAGUTI F15 FIREFOX). **Federn:** (MINARELLI HARD GELBE).

**DISEGNO TECNICO RULLI E MOLLE - TECHNICAL DRAWING ROLLERS AND SPRINGS
CROQUIS TECHNIQUE MASSELOTTES ET RESSORTS - TECHNISCHE ZEICHNUNG ROLLEN UND FEDERN
DISEÑO TÉCNICO RODILLOS Y MUELLES**

FIGURA 1

- * Battuta rullo
- * Roller beat
- * Retour plastique
- * Anschlag der rolle
- * Batiente de rodillo



FIGURA 2

Senso di rotazione
Clock-wise rotation
Sens de rotation
Drehrichtung
Sentido de rotación

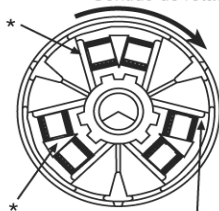

- * Battuta rullo
- * Roller beat
- * Retour plastique
- * Anschlag der rolle
- * Batiente de rodillo

**MOLLE DA SOSTITUIRE - SPRINGS TO BE REPLACED
RESSORTS À REMPLACER - ZU ERSETZENDE FEDER
MUELLES PARA SUSTITUCIÓN**

FIGURA 3

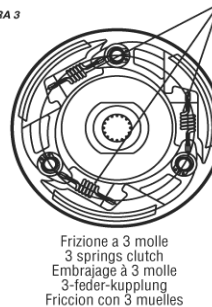

Frizione a 3 molle
3 springs clutch
Embrajage à 3 molle
3-feder-kupplung
Friction con 3 muelles

FIGURA 4

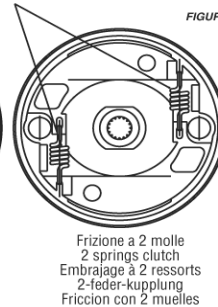

Frizione a 2 molle
2 springs clutch
Embrajage à 2 ressorts
2-feder-kupplung
Friction con 2 muelles

VISTA DAL LATO INTERNO - VIEW FROM THE INNER SIDE
VUE DE L'INTÉRIEUR - ANSICHT VON INNENSEITE
VISTA DESDE EL LADO INTERIOR

LO9933380